

PROJECT	
TYPE	
SPECIFIER	
QUANTITY	
DATE	

## CRYSTAL GALAXY SUSPENSION

### D101389-

base number	LED	Color	Finish
	Dimming	Temperature	Options

- To build a product code in our configurator select the specify button on the base model # product page
- To build a manual product code on this datasheet choose from the options listed below in blue font and add the suffix to the base model #

#### GENERAL

Series: Crystal Galaxy
Brand: Quasar
Division: Design
Mounting Type: Suspension
Mounting Location: Ceiling
Subcategory: Ambient

#### PHYSICAL

Shape: Abstract
Diameter (mm): 800
Diameter (in): 31 1/2
Height (mm): 800
Height (in): 31 1/2
Max. Overall Height (mm): 2000
Max. Overall Height (in): 78 3/4
Light Distribution: Omnidirectional
Weight (kg): 3
Weight (lbs): 6.61
Diffuser: Asfour Crystals
Fixture Finish: <a href="#">NIC / BRA / BBR</a>
Fixture Material: Metal
Upon Request: Custom Sizes

#### ELECTRICAL

Number of Lamps: 60
Lamp Type: LED Retrofit
Input Wattage (W): 19.8
Bulb Included: Bulb Included
Max. Wattage Per Lamp (W): 0.33
Lamp Base: E10
Dimming: <a href="#">0-10V Dimming / Phase Dimming (120Vac Only)</a>
Driver Included: Yes
Driver Location: Integrated
Driver Type: Constant Voltage - Universal
Driver Class: Class 2
Input Voltage (V): 120 - 277
Output Voltage (V): 12
Lamp Voltage (V): 12

#### LED

Color Temperature (°K): <a href="#">2600 / 3000 / 3500</a>
Max. Delivered Lumen (lm): 1380 (2600K)
CRI: >90 CRI
Lamp Life (hrs): 50000

#### OPTICAL

#### RATINGS AND CERTIFICATIONS

Certified By: Certified for North American Standards
IP rating: IP20

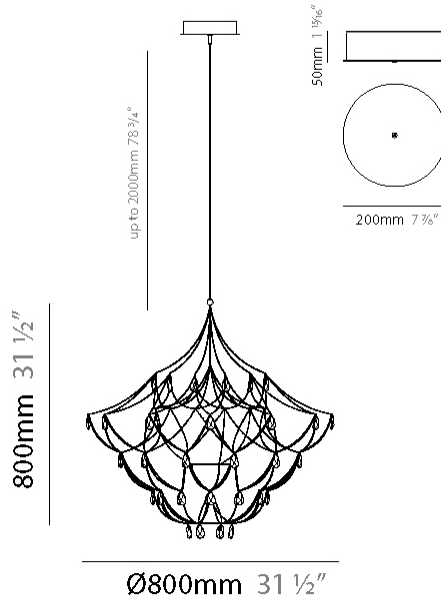

## CRYSTAL GALAXY SUSPENSION

D101389-

PROJECT

TYPE

SPECIFIER

QUANTITY

DATE



## CRYSTAL GALAXY SUSPENSION

### D101390-

base number    LED Dimming    Color Temperature    Finish Options

- To build a product code in our configurator select the specify button on the base model # product page
- To build a manual product code on this datasheet choose from the options listed below in blue font and add the suffix to the base model #

#### GENERAL

Series: Crystal Galaxy  
 Brand: Quasar  
 Division: Design  
 Mounting Type: Suspension  
 Mounting Location: Ceiling  
 Subcategory: Ambient

#### PHYSICAL

Shape: Abstract  
 Diameter (mm): 800  
 Diameter (in): 31 1/2  
 Height (mm): 800  
 Height (in): 31 1/2  
 Max. Overall Height (mm): 2000  
 Max. Overall Height (in): 78 3/4  
 Light Distribution: Omnidirectional  
 Diffuser: Asfour Crystals  
 Fixture Finish: [NIC / BRA / BBR](#)  
 Fixture Material: Metal  
 Upon Request: Custom Sizes

#### ELECTRICAL

Number of Lamps: 60 + 1  
 Lamp Type: LED Retrofit  
 Input Wattage (W): 26.8  
 Bulb Included: Bulb Included  
 Max. Wattage Per Lamp (W): 0.33 + 7  
 Lamp Base: E10 + GU10  
 Dimming: [0-10V Dimming / Phase Dimming \(120Vac Only\)](#)  
 Driver Included: Yes  
 Driver Location: Integrated  
 Driver Type: Constant Voltage - Universal  
 Driver Class: Class 2  
 Input Voltage (V): 120 - 277  
 Output Voltage (V): 12  
 Lamp Voltage (V): 12

#### LED

Color Temperature (°K): [2600 / 3000 / 3500](#)  
 CRI: >90 CRI  
 Lamp Life (hrs): 50000

#### OPTICAL

#### RATINGS AND CERTIFICATIONS

Certified By: Certified for North American Standards  
 IP rating: IP20

PROJECT
TYPE
SPECIFIER
QUANTITY
DATE

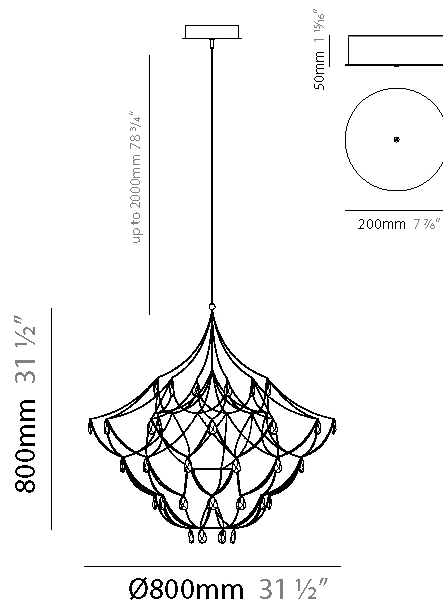

## CRYSTAL GALAXY SUSPENSION

D101390-

PROJECT

TYPE

SPECIFIER

QUANTITY

DATE



D

## CRYSTAL GALAXY SUSPENSION

### D101393-

base number    LED Dimming    Color Temperature    Finish Options

- To build a product code in our configurator select the specify button on the base model # product page
- To build a manual product code on this datasheet choose from the options listed below in blue font and add the suffix to the base model #

#### GENERAL

Series: Crystal Galaxy  
 Brand: Quasar  
 Division: Design  
 Mounting Type: Suspension  
 Mounting Location: Ceiling  
 Subcategory: Ambient

#### PHYSICAL

Shape: Abstract  
 Diameter (mm): 600  
 Diameter (in): 23 5/8  
 Height (mm): 600  
 Height (in): 23 5/8  
 Max. Overall Height (mm): 2000  
 Max. Overall Height (in): 78 3/4  
 Light Distribution: Omnidirectional  
 Weight (kg): 3  
 Weight (lbs): 6.61  
 Fixture Finish: NIC / BRA / BBR  
 Fixture Material: Metal  
 Upon Request: Custom Sizes

#### ELECTRICAL

Number of Lamps: 48  
 Lamp Type: LED Retrofit  
 Input Wattage (W): 15.84  
 Bulb Included: Bulb Included  
 Max. Wattage Per Lamp (W): 0.33  
 Lamp Base: E10  
 Dimming: 0-10V Dimming / Phase Dimming (120Vac Only)  
 Driver Included: Yes  
 Driver Location: Integrated  
 Driver Type: Constant Voltage - Universal  
 Driver Class: Class 2  
 Input Voltage (V): 120 - 277  
 Output Voltage (V): 12  
 Lamp Voltage (V): 12

#### LED

Color Temperature (°K): 2600 / 3000 / 3500  
 Max. Delivered Lumen (lm): 1104 (2600K)  
 CRI: >90 CRI  
 Lamp Life (hrs): 50000

#### OPTICAL

#### RATINGS AND CERTIFICATIONS

Certified By: Certified for North American Standards  
 IP rating: IP20

PROJECT
TYPE
SPECIFIER
QUANTITY
DATE

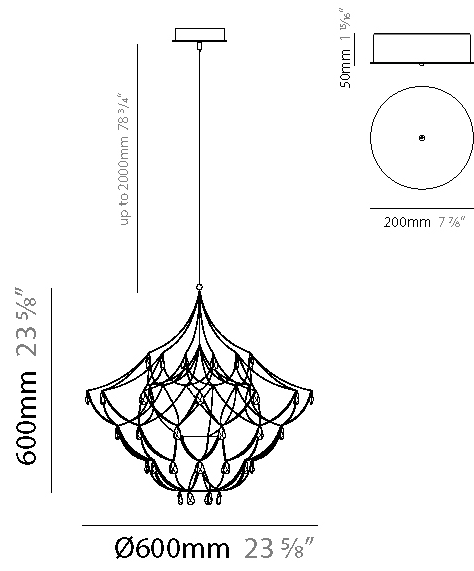

## CRYSTAL GALAXY SUSPENSION

D101393-

PROJECT \_\_\_\_\_

TYPE \_\_\_\_\_

SPECIFIER \_\_\_\_\_

QUANTITY \_\_\_\_\_

DATE \_\_\_\_\_

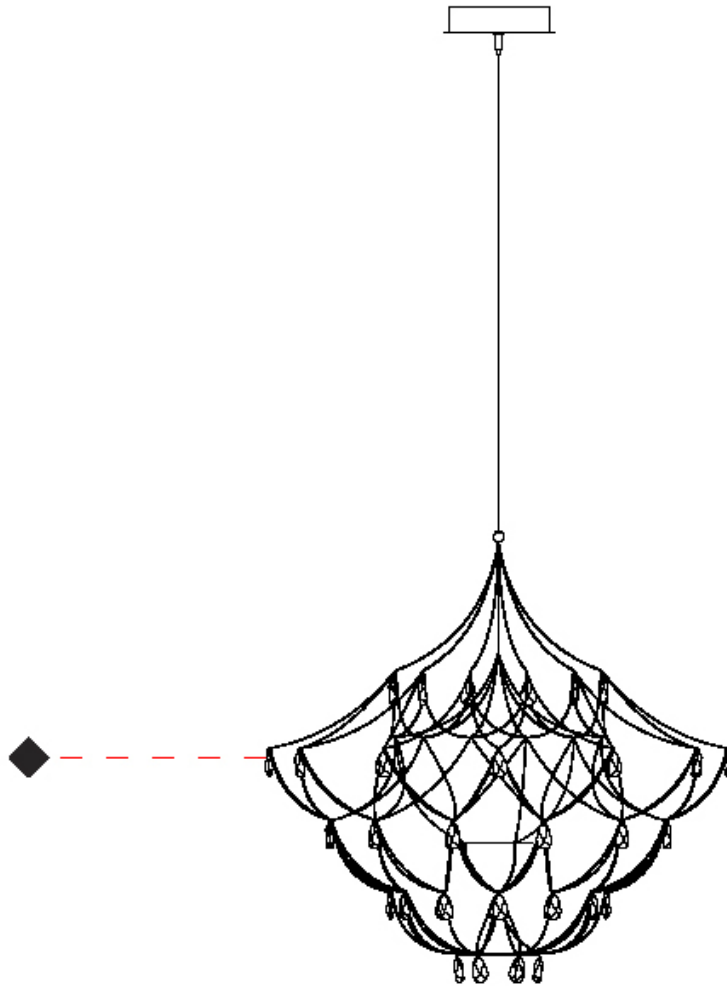

D

PROJECT	
TYPE	
SPECIFIER	
QUANTITY	
DATE	

## CRYSTAL GALAXY SUSPENSION

### D101394-

base number	LED Dimming	Color Temperature	Finish Options
-------------	----------------	----------------------	-------------------

- To build a product code in our configurator select the specify button on the base model # product page
- To build a manual product code on this datasheet choose from the options listed below in blue font and add the suffix to the base model #

#### GENERAL

Series: Crystal Galaxy
Brand: Quasar
Division: Design
Mounting Type: Suspension
Mounting Location: Ceiling
Subcategory: Ambient

#### PHYSICAL

Shape: Abstract
Diameter (mm): 600
Diameter (in): 23 5/8
Height (mm): 600
Height (in): 23 5/8
Max. Overall Height (mm): 2000
Max. Overall Height (in): 78 3/4
Light Distribution: Omnidirectional
Fixture Finish: <a href="#">NIC</a> / <a href="#">BRA</a> / <a href="#">BBR</a>
Fixture Material: Metal
Upon Request: Custom Sizes

#### ELECTRICAL

Number of Lamps: 48 + 1
Lamp Type: LED Retrofit
Input Wattage (W): 22.84
Bulb Included: Bulb Included
Max. Wattage Per Lamp (W): 0.33 + 7
Lamp Base: E10 + GU10
<a href="#">Dimming: 0-10V Dimming / Phase Dimming (120Vac Only)</a>
Driver Included: Yes
Driver Location: Integrated
Driver Type: Constant Voltage - Universal
Driver Class: Class 2
Input Voltage (V): 120 - 277
Output Voltage (V): 12
Lamp Voltage (V): 12

#### LED

<a href="#">Color Temperature (*K): 2600 / 3000 / 3500</a>
CRI: >90 CRI
Lamp Life (hrs): 50000

#### OPTICAL

#### RATINGS AND CERTIFICATIONS

Certified By: Certified for North American Standards
IP rating: IP20

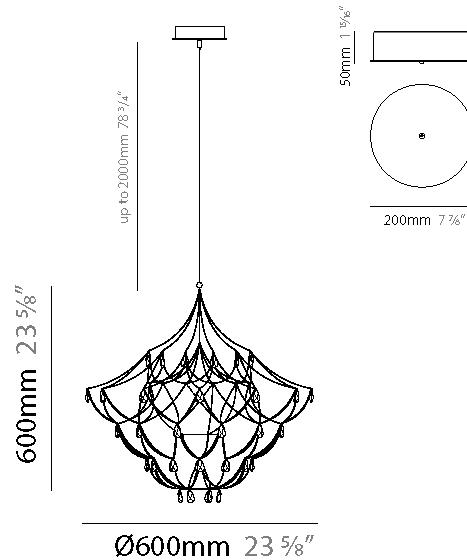

## CRYSTAL GALAXY SUSPENSION

D101394-

PROJECT

TYPE

SPECIFIER

QUANTITY

DATE

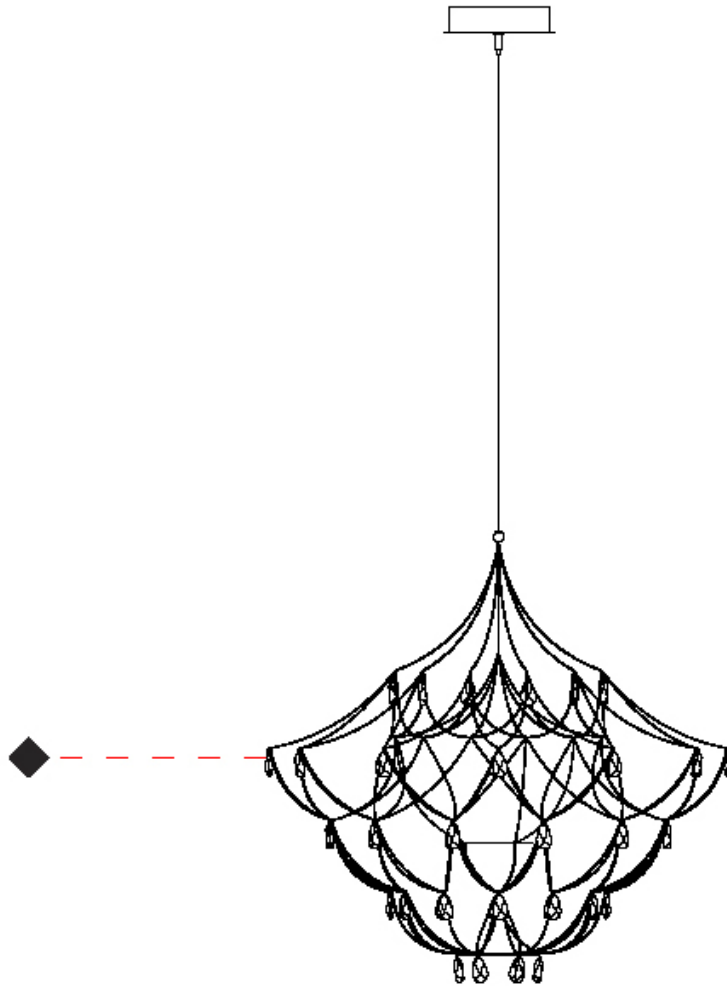



PROJECT	
TYPE	
SPECIFIER	
QUANTITY	
DATE	

## CRYSTAL GALAXY SUSPENSION

### D101397-

base number	LED Dimming	Color Temperature	Finish Options
-------------	-------------	-------------------	----------------

- To build a product code in our configurator select the specify button on the base model # product page
- To build a manual product code on this datasheet choose from the options listed below in blue font and add the suffix to the base model #

#### GENERAL

Series: Crystal Galaxy
Brand: Quasar
Division: Design
Mounting Type: Suspension
Mounting Location: Ceiling
Subcategory: Ambient

#### PHYSICAL

Shape: Abstract
Diameter (mm): 1000
Diameter (in): 39 3/8
Height (mm): 1000
Height (in): 39 3/8
Max. Overall Height (mm): 2000
Max. Overall Height (in): 78 3/4
Light Distribution: Omnidirectional
Weight (kg): 3
Weight (lbs): 6.61
Fixture Finish: NIC / BRA / BBR
Fixture Material: Metal
Upon Request: Custom Sizes

#### ELECTRICAL

Number of Lamps: 75
Lamp Type: LED Retrofit
Input Wattage (W): 24.75
Bulb Included: Bulb Included
Max. Wattage Per Lamp (W): 0.33
Lamp Base: E12
Dimming: 0-10V Dimming / Phase Dimming (120Vac Only)
Driver Included: Yes
Driver Location: Integrated
Driver Type: Constant Voltage - Universal
Driver Class: Class 2
Input Voltage (V): 120 - 277
Output Voltage (V): 12
Lamp Voltage (V): 12

#### LED

Color Temperature (°K): 2600 / 3000 / 3500
Max. Delivered Lumen (lm): 1725 (2600K)
CRI: >80 CRI
Lamp Life (hrs): 50000

#### OPTICAL

#### RATINGS AND CERTIFICATIONS

Certified By: Certified for North American Standards
IP rating: IP20

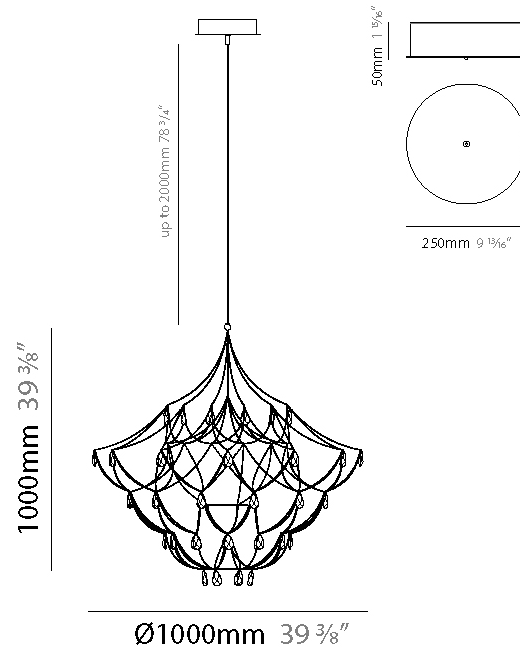

## CRYSTAL GALAXY SUSPENSION

D101397-

PROJECT

TYPE

SPECIFIER

QUANTITY

DATE

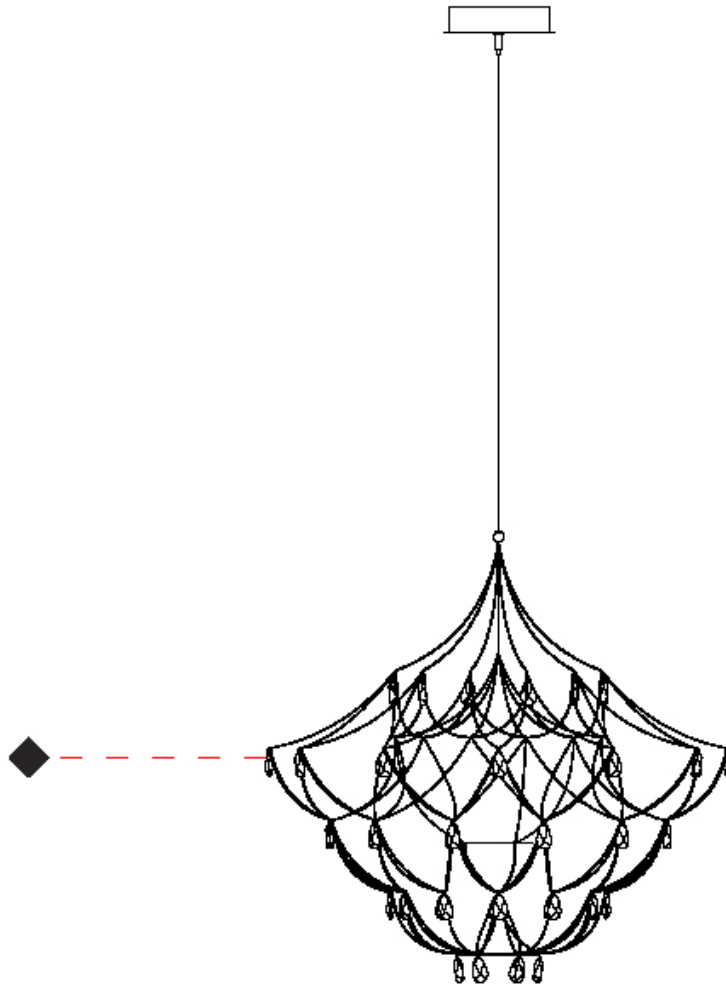

PROJECT	_____
TYPE	_____
SPECIFIER	_____
QUANTITY	_____
DATE	_____

## CRYSTAL GALAXY SUSPENSION

### D101398-

base number	LED Dimming	Color Temperature	Finish Options
-------------	-------------	-------------------	----------------

- To build a product code in our configurator select the specify button on the base model # product page
- To build a manual product code on this datasheet choose from the options listed below in blue font and add the suffix to the base model #

#### GENERAL

Series: Crystal Galaxy
Brand: Quasar
Division: Design
Mounting Type: Suspension
Mounting Location: Ceiling
Subcategory: Ambient

#### PHYSICAL

Shape: Abstract
Diameter (mm): 1000
Diameter (in): 39 3/8"
Height (mm): 1000
Height (in): 39 3/8"
Max. Overall Height (mm): 2000
Max. Overall Height (in): 78 3/4"
Light Distribution: Omnidirectional
Fixture Finish: <a href="#">NIC</a> / <a href="#">BRA</a> / <a href="#">BBR</a>
Fixture Material: Metal
Upon Request: Custom Sizes

#### ELECTRICAL

Number of Lamps: 75 + 1
Lamp Type: LED Retrofit
Input Wattage (W): 31.75
Bulb Included: Bulb Included
Max. Wattage Per Lamp (W): 0.33 + 7
Lamp Base: E10 + GU10
Dimming: <a href="#">0-10V Dimming</a> / <a href="#">Phase Dimming (120Vac Only)</a>
Driver Included: Yes
Driver Location: Integrated
Driver Type: Constant Voltage - Universal
Driver Class: Class 2
Input Voltage (V): 120 - 277
Output Voltage (V): 12
Lamp Voltage (V): 12

#### LED

Color Temperature (*K): <a href="#">2600</a> / <a href="#">3000</a> / <a href="#">3500</a>
CRI: >90 CRI
Lamp Life (hrs): 50000

#### OPTICAL

#### RATINGS AND CERTIFICATIONS

Certified By: Certified for North American Standards
IP rating: IP20

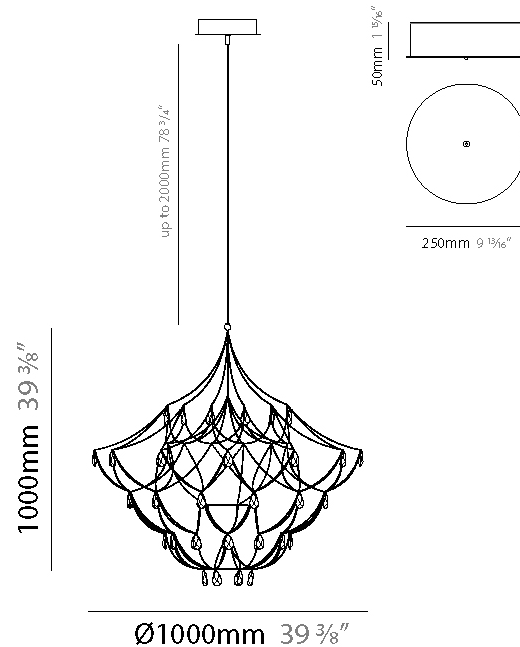

## CRYSTAL GALAXY SUSPENSION

D101398-

PROJECT

TYPE

SPECIFIER

QUANTITY

DATE



PROJECT	_____
TYPE	_____
SPECIFIER	_____
QUANTITY	_____
DATE	_____

## CRYSTAL GALAXY SUSPENSION

### D101401-

base number	LED	Color	Finish
	Dimming	Temperature	Options

- To build a product code in our configurator select the specify button on the base model # product page
- To build a manual product code on this datasheet choose from the options listed below in blue font and add the suffix to the base model #

#### GENERAL

Series: Crystal Galaxy
Brand: Quasar
Division: Design
Mounting Type: Suspension
Mounting Location: Ceiling
Subcategory: Ambient

#### PHYSICAL

Shape: Abstract
Diameter (mm): 1200
Diameter (in): 47 1/4
Height (mm): 1200
Height (in): 47 1/4
Max. Overall Height (mm): 3200
Max. Overall Height (in): 126
Light Distribution: Omnidirectional
Weight (kg): 4
Weight (lbs): 8.82
Fixture Finish: <a href="#">NIC</a> / <a href="#">BRA</a> / <a href="#">BBR</a>
Fixture Material: Metal
Cable Details: 2000mm Cable
Upon Request: Custom Sizes

#### ELECTRICAL

Number of Lamps: 108
Lamp Type: LED Retrofit
Input Wattage (W): 35.64
Bulb Included: Bulb Included
Max. Wattage Per Lamp (W): 0.33
Lamp Base: E10
Dimming: <a href="#">0-10V Dimming</a> / <a href="#">Phase Dimming (120Vac Only)</a>
Driver Included: Yes
Driver Location: Integrated
Driver Type: Constant Voltage - Universal
Driver Class: Class 2
Input Voltage (V): 120 - 277
Output Voltage (V): 12
Lamp Voltage (V): 12

#### LED

Color Temperature (*K): <a href="#">2600</a> / <a href="#">3000</a> / <a href="#">3500</a>
Max. Delivered Lumen (lm): 2484 (2600K)
CRI: >90 CRI
Lamp Life (hrs): 50000

#### OPTICAL

#### RATINGS AND CERTIFICATIONS

Certified By: Certified for North American Standards
IP rating: IP20

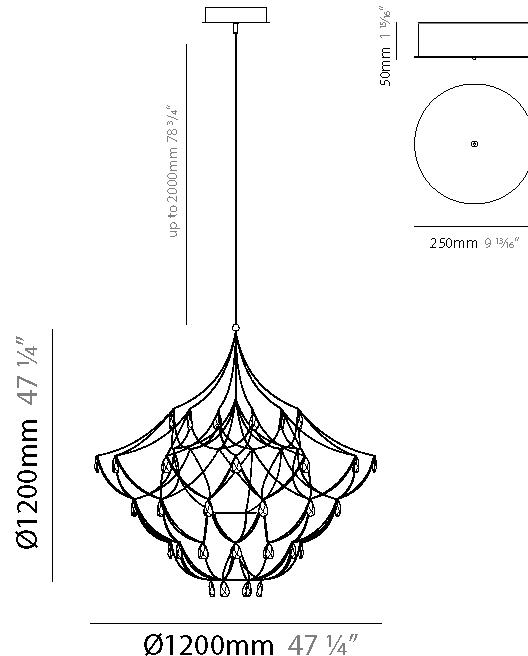

## CRYSTAL GALAXY SUSPENSION

D101401-

PROJECT

TYPE

SPECIFIER

QUANTITY

DATE

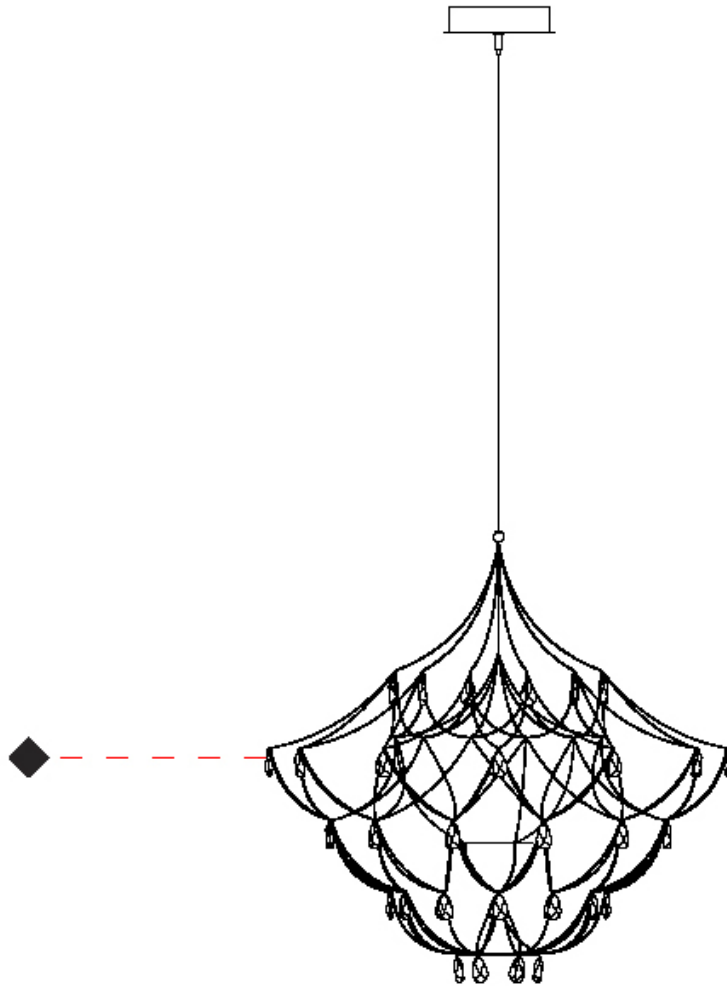

PROJECT	_____
TYPE	_____
SPECIFIER	_____
QUANTITY	_____
DATE	_____

## CRYSTAL GALAXY SUSPENSION

### D101402-

base number	LED Dimming	Color Temperature	Finish Options
-------------	----------------	----------------------	-------------------

- To build a product code in our configurator select the specify button on the base model # product page
- To build a manual product code on this datasheet choose from the options listed below in blue font and add the suffix to the base model #

#### GENERAL

Series: Crystal Galaxy
Brand: Quasar
Division: Design
Mounting Type: Suspension
Mounting Location: Ceiling
Subcategory: Ambient

#### PHYSICAL

Shape: Abstract
Diameter (mm): 1200
Diameter (in): 47 1/4
Height (mm): 1200
Height (in): 47 1/4
Max. Overall Height (mm): 3200
Max. Overall Height (in): 126
Light Distribution: Omnidirectional
Fixture Finish: <a href="#">NIC</a> / <a href="#">BRA</a> / <a href="#">BBR</a>
Fixture Material: Metal
Cable Details: 2000mm Cable
Upon Request: Custom Sizes

#### ELECTRICAL

Number of Lamps: 108 + 1
Lamp Type: LED Retrofit
Input Wattage (W): 42.64
Bulb Included: Bulb Included
Max. Wattage Per Lamp (W): 0.33 + 7
Lamp Base: E10 + GU10
Dimming: <a href="#">0-10V Dimming</a> / <a href="#">Phase Dimming (120Vac Only)</a>
Driver Included: Yes
Driver Location: Integrated
Driver Type: Constant Voltage - Universal
Driver Class: Class 2
Input Voltage (V): 120 - 277
Output Voltage (V): 12
Lamp Voltage (V): 12

#### LED

Color Temperature (°K): <a href="#">2600</a> / <a href="#">3000</a> / <a href="#">3500</a>
CRI: >90 CRI
Lamp Life (hrs): 50000

#### OPTICAL

#### RATINGS AND CERTIFICATIONS

Certified By: Certified for North American Standards
IP rating: IP20

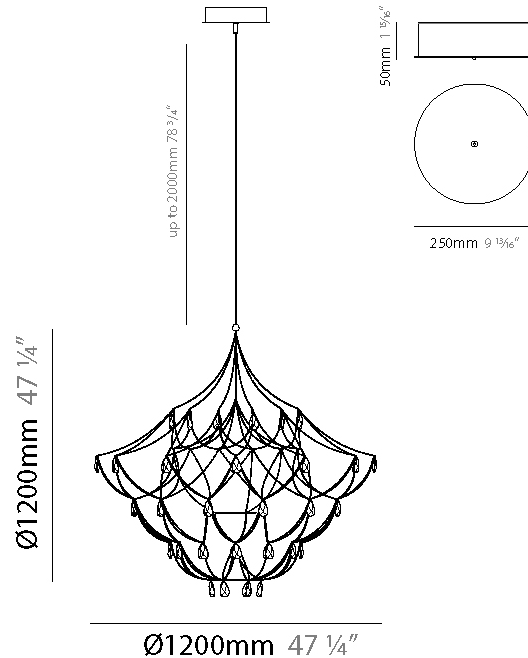



## CRYSTAL GALAXY SUSPENSION

D101402-

PROJECT

TYPE

SPECIFIER

QUANTITY

DATE

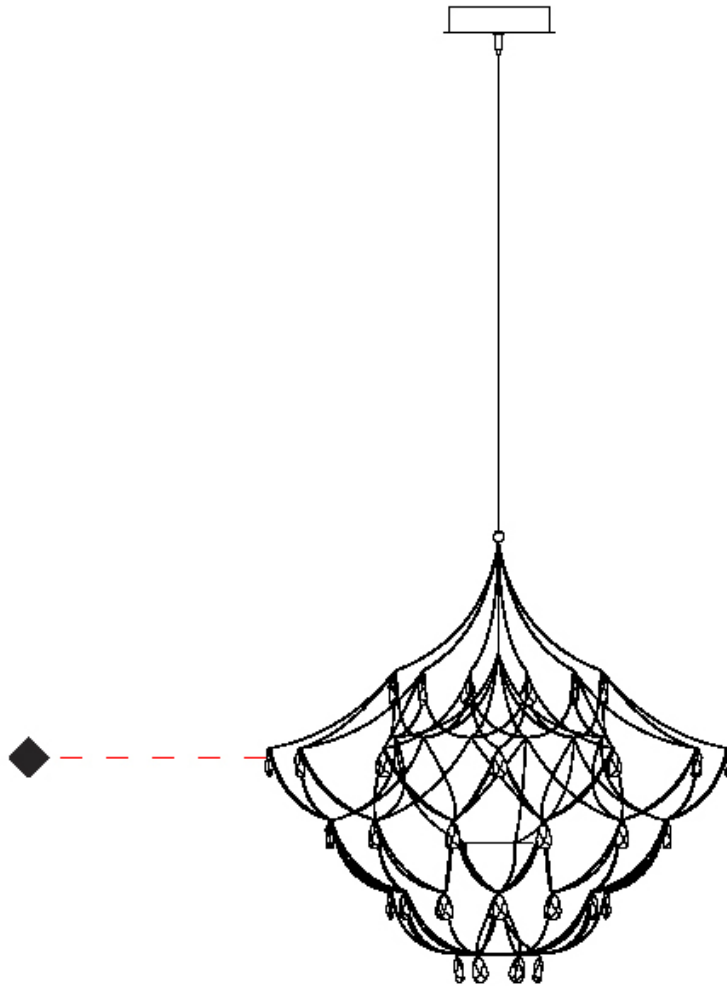



PROJECT	
TYPE	
SPECIFIER	
QUANTITY	
DATE	

## CRYSTAL GALAXY SUSPENSION

### D101405-

base number	LED	Color	Finish
	Dimming	Temperature	Options

- To build a product code in our configurator select the specify button on the base model # product page
- To build a manual product code on this datasheet choose from the options listed below in blue font and add the suffix to the base model #

#### GENERAL

Series: Crystal Galaxy
Brand: Quasar
Division: Design
Mounting Type: Suspension
Mounting Location: Ceiling
Subcategory: Ambient

#### PHYSICAL

Shape: Abstract
Diameter (mm): 1400
Diameter (in): 55 1/8"
Height (mm): 1400
Height (in): 55 1/8"
Max. Overall Height (mm): 3400
Max. Overall Height (in): 133 7/8"
Light Distribution: Omnidirectional
Weight (kg): 5
Weight (lbs): 11.02
Fixture Finish: <a href="#">NIC</a> / <a href="#">BRA</a> / <a href="#">BBR</a>
Fixture Material: Metal
Cable Details: 2000mm Cable

#### ELECTRICAL

Number of Lamps: 126
Lamp Type: LED Retrofit
Input Wattage (W): 41.58
Bulb Included: Bulb Included
Max. Wattage Per Lamp (W): 0.33
Lamp Base: E10
Dimming: <a href="#">0-10V Dimming</a> / <a href="#">Phase Dimming (120Vac Only)</a>
Driver Included: Yes
Driver Location: Integrated
Driver Type: Constant Voltage - Universal
Driver Class: Class 2
Input Voltage (V): 120 - 277
Output Voltage (V): 12
Lamp Voltage (V): 12

#### LED

Color Temperature (°K): <a href="#">2600</a> / <a href="#">3000</a> / <a href="#">3500</a>
Max. Delivered Lumen (lm): 2898 (2600K)
CRI: >80 CRI
Lamp Life (hrs): 50000

#### OPTICAL

#### RATINGS AND CERTIFICATIONS

Certified By: Certified for North American Standards
IP rating: IP20

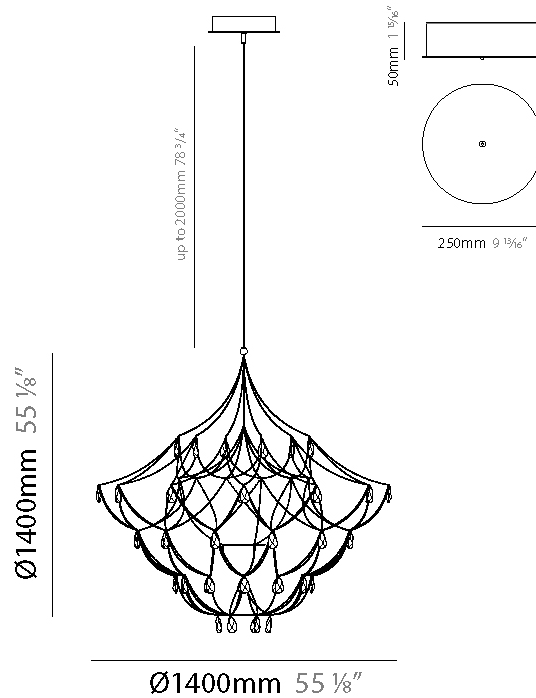

## CRYSTAL GALAXY SUSPENSION

D101405-

PROJECT

TYPE

SPECIFIER

QUANTITY

DATE



PROJECT	
TYPE	
SPECIFIER	
QUANTITY	
DATE	

## CRYSTAL GALAXY SUSPENSION

### D101409-

base number	LED	Color	Finish
	Dimming	Temperature	Options

- To build a product code in our configurator select the specify button on the base model # product page
- To build a manual product code on this datasheet choose from the options listed below in blue font and add the suffix to the base model #

#### GENERAL

Series: Crystal Galaxy
Brand: Quasar
Division: Design
Mounting Type: Suspension
Mounting Location: Ceiling
Subcategory: Ambient

#### PHYSICAL

Shape: Abstract
Diameter (mm): 1600
Diameter (in): 63
Height (mm): 1600
Height (in): 63
Max. Overall Height (mm): 3600
Max. Overall Height (in): 141 3/4
Light Distribution: Omnidirectional
Weight (kg): 6
Weight (lbs): 13.23
Fixture Finish: <a href="#">NIC / BRA / BBR</a>
Fixture Material: Metal
Cable Details: 2000mm Cable
Upon Request: Custom Sizes

#### ELECTRICAL

Number of Lamps: 144
Lamp Type: LED Retrofit
Input Wattage (W): 47.52
Bulb Included: Bulb Included
Max. Wattage Per Lamp (W): 0.33
Lamp Base: E10
<a href="#">Dimming: 0-10V Dimming / Phase Dimming (120Vac Only)</a>
Driver Included: Yes
Driver Location: Integrated
Driver Type: Constant Voltage - Universal
Driver Class: Class 2
Input Voltage (V): 120 - 277
Output Voltage (V): 12
Lamp Voltage (V): 12

#### LED

<a href="#">Color Temperature (°K): 2600 / 3000 / 3500</a>
Max. Delivered Lumen (lm): 3312 (2600K)
CRI: >90 CRI
Lamp Life (hrs): 50000

#### OPTICAL

#### RATINGS AND CERTIFICATIONS

Certified By: Certified for North American Standards
IP rating: IP20

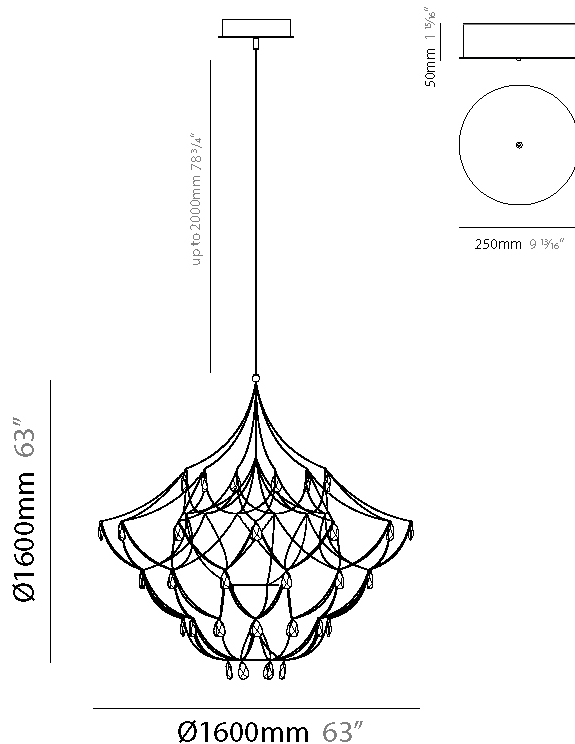

## CRYSTAL GALAXY SUSPENSION

D101409-

PROJECT

TYPE

SPECIFIER

QUANTITY

DATE



D

PROJECT	_____
TYPE	_____
SPECIFIER	_____
QUANTITY	_____
DATE	_____

## CRYSTAL GALAXY SUSPENSION

### D101410-

base number	LED	Color	Finish
	Dimming	Temperature	Options

- To build a product code in our configurator select the specify button on the base model # product page
- To build a manual product code on this datasheet choose from the options listed below in blue font and add the suffix to the base model #

#### GENERAL

Series: Crystal Galaxy
Brand: Quasar
Division: Design
Mounting Type: Suspension
Mounting Location: Ceiling
Subcategory: Ambient

#### PHYSICAL

Shape: Abstract
Diameter (mm): 1600
Diameter (in): 63
Height (mm): 1600
Height (in): 63
Max. Overall Height (mm): 3600
Max. Overall Height (in): 141 3/4
Light Distribution: Omnidirectional
Fixture Finish: <a href="#">NIC</a> / <a href="#">BRA</a> / <a href="#">BBR</a>
Fixture Material: Metal
Cable Details: 2000mm Cable
Upon Request: Custom Sizes

#### ELECTRICAL

Number of Lamps: 144 + 1
Lamp Type: LED Retrofit
Input Wattage (W): 54.52
Bulb Included: Bulb Included
Max. Wattage Per Lamp (W): 0.33 + 7
Lamp Base: E10 + GU10
Dimming: <a href="#">0-10V Dimming</a> / <a href="#">Phase Dimming (120Vac Only)</a>
Driver Included: Yes
Driver Location: Integrated
Driver Type: Constant Voltage - Universal
Driver Class: Class 2
Input Voltage (V): 120 - 277
Output Voltage (V): 12
Lamp Voltage (V): 12

#### LED

Color Temperature (°K): <a href="#">2600</a> / <a href="#">3000</a> / <a href="#">3500</a>
CRI: >90 CRI
Lamp Life (hrs): 50000

#### OPTICAL

#### RATINGS AND CERTIFICATIONS

Certified By: Certified for North American Standards
IP rating: IP20

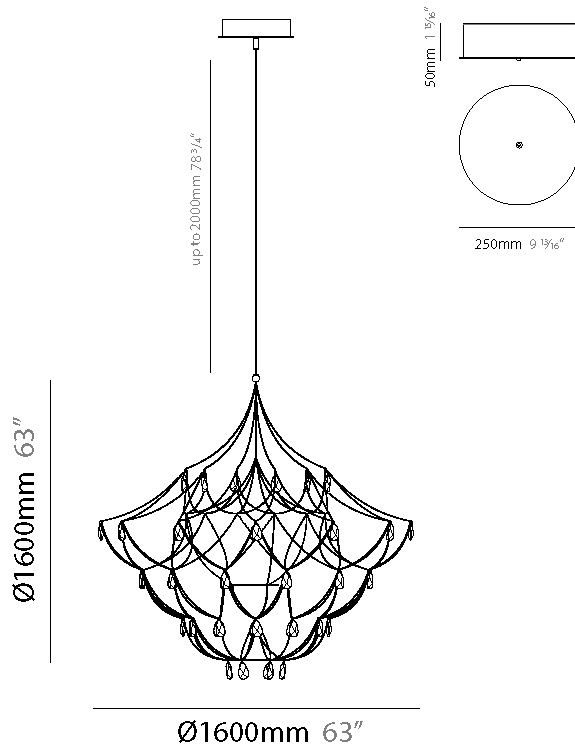

## CRYSTAL GALAXY SUSPENSION

D101410-

PROJECT

TYPE

SPECIFIER

QUANTITY

DATE

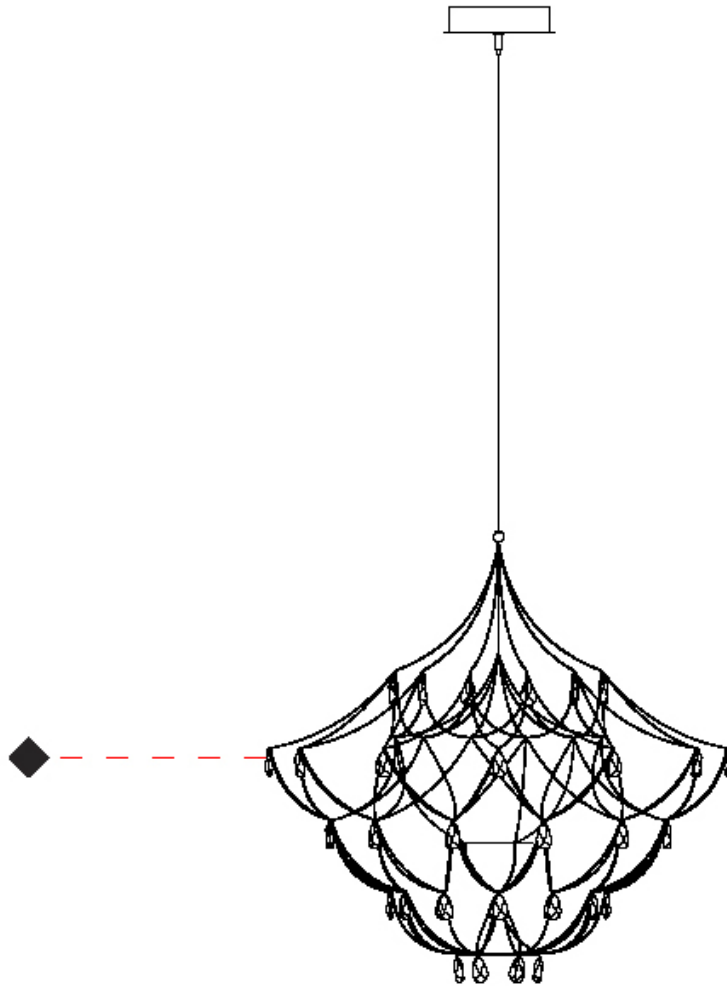



PROJECT	_____
TYPE	_____
SPECIFIER	_____
QUANTITY	_____
DATE	_____

## CRYSTAL GALAXY SUSPENSION

### D101413-

base number	LED	Color	Finish
	Dimming	Temperature	Options

- To build a product code in our configurator select the specify button on the base model # product page
- To build a manual product code on this datasheet choose from the options listed below in blue font and add the suffix to the base model #

#### GENERAL

Series: Crystal Galaxy
Brand: Quasar
Division: Design
Mounting Type: Suspension
Mounting Location: Ceiling
Subcategory: Ambient

#### PHYSICAL

Shape: Abstract
Diameter (mm): 1800
Diameter (in): 70 7/8
Height (mm): 1800
Height (in): 70 7/8
Max. Overall Height (mm): 3800
Max. Overall Height (in): 149 5/8
Light Distribution: Omnidirectional
Weight (kg): 7
Weight (lbs): 15.43
Fixture Finish: <a href="#">NIC</a> / <a href="#">BRA</a> / <a href="#">BBR</a>
Fixture Material: Metal
Cable Details: 2000mm Cable
Upon Request: Custom Sizes

#### ELECTRICAL

Number of Lamps: 150
Lamp Type: LED Retrofit
Input Wattage (W): 49.5
Bulb Included: Bulb Included
Max. Wattage Per Lamp (W): 0.33
Lamp Base: E10
<a href="#">Dimming: 0-10V Dimming / Phase Dimming (120Vac Only)</a>
Driver Included: Yes
Driver Location: Integrated
Driver Type: Constant Voltage - Universal
Driver Class: Class 2
Input Voltage (V): 120 - 277
Output Voltage (V): 12
Lamp Voltage (V): 12

#### LED

<a href="#">Color Temperature (°K): 2600 / 3000 / 3500</a>
Max. Delivered Lumen (lm): 3450 (2600K)
CRI: >90 CRI
Lamp Life (hrs): 50000

#### OPTICAL

#### RATINGS AND CERTIFICATIONS

Certified By: Certified for North American Standards
IP rating: IP20

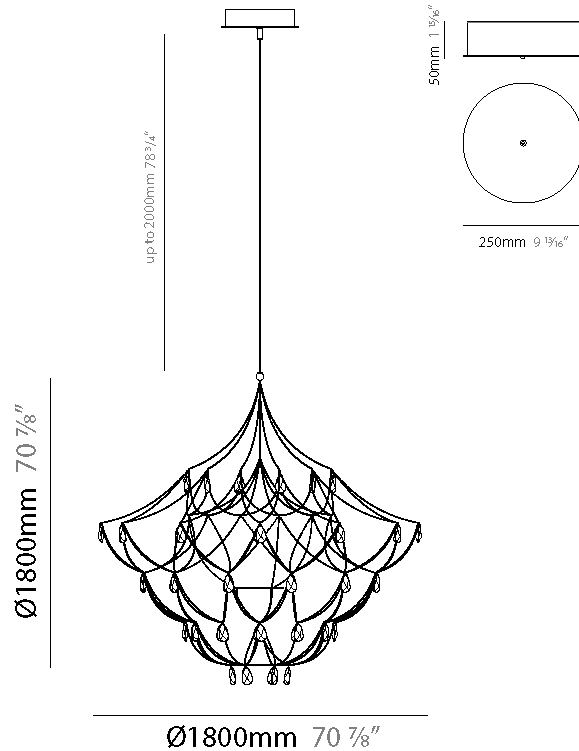

## CRYSTAL GALAXY SUSPENSION

D101413-

PROJECT

TYPE

SPECIFIER

QUANTITY

DATE



D



PROJECT	_____
TYPE	_____
SPECIFIER	_____
QUANTITY	_____
DATE	_____

## CRYSTAL GALAXY SUSPENSION

### D101414-

base number	LED	Color	Finish
	Dimming	Temperature	Options

- To build a product code in our configurator select the specify button on the base model # product page
- To build a manual product code on this datasheet choose from the options listed below in blue font and add the suffix to the base model #

#### GENERAL

Series: Crystal Galaxy
Brand: Quasar
Division: Design
Mounting Type: Suspension
Mounting Location: Ceiling
Subcategory: Ambient

#### PHYSICAL

Shape: Abstract
Diameter (mm): 1800
Diameter (in): 70 7/8
Height (mm): 1800
Height (in): 70 7/8
Max. Overall Height (mm): 3800
Max. Overall Height (in): 149 5/8
Light Distribution: Omnidirectional
Fixture Finish: <a href="#">NIC</a> / <a href="#">BRA</a> / <a href="#">BBR</a>
Fixture Material: Metal
Cable Details: 2000mm Cable
Upon Request: Custom Sizes

#### ELECTRICAL

Number of Lamps: 150 + 1
Lamp Type: LED Retrofit
Input Wattage (W): 56.5
Bulb Included: Bulb Included
Max. Wattage Per Lamp (W): 0.33 + 7
Lamp Base: E10 + GU10
<a href="#">Dimming: 0-10V Dimming / Phase Dimming (120Vac Only)</a>
Driver Included: Yes
Driver Location: Integrated
Driver Type: Constant Voltage - Universal
Driver Class: Class 2
Input Voltage (V): 120 - 277
Output Voltage (V): 12
Lamp Voltage (V): 12

#### LED

<a href="#">Color Temperature (°K): 2600</a>
CRI: >90 CRI
Lamp Life (hrs): 50000

#### OPTICAL

#### RATINGS AND CERTIFICATIONS

Certified By: Certified for North American Standards
IP rating: IP20

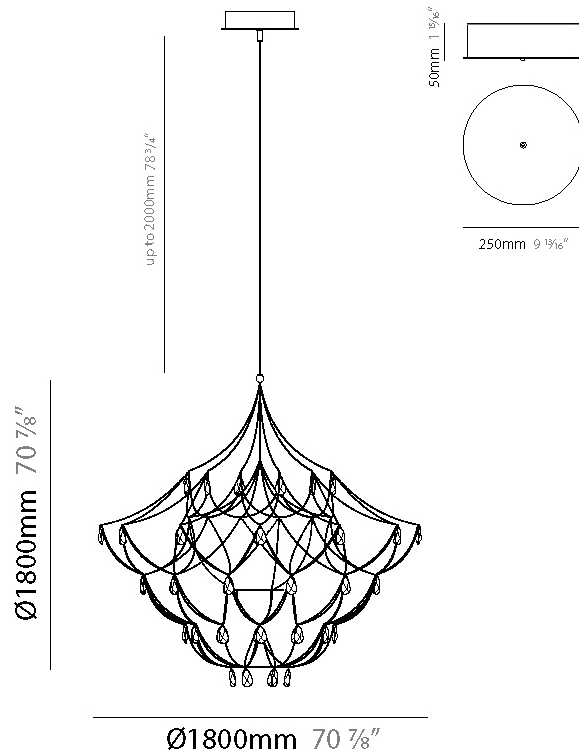

## CRYSTAL GALAXY SUSPENSION

D101414-

PROJECT

TYPE

SPECIFIER

QUANTITY

DATE



D

PROJECT	_____
TYPE	_____
SPECIFIER	_____
QUANTITY	_____
DATE	_____

## CRYSTAL GALAXY SUSPENSION

### D101417-

base number	LED	Color	Finish
	Dimming	Temperature	Options

- To build a product code in our configurator select the specify button on the base model # product page
- To build a manual product code on this datasheet choose from the options listed below in blue font and add the suffix to the base model #

#### GENERAL

Series: Crystal Galaxy
Brand: Quasar
Division: Design
Mounting Type: Suspension
Mounting Location: Ceiling
Subcategory: Ambient

#### PHYSICAL

Shape: Abstract
Diameter (mm): 2000
Diameter (in): 78 3/4
Height (mm): 2000
Height (in): 78 3/4
Max. Overall Height (mm): 4000
Max. Overall Height (in): 157 1/2
Light Distribution: Omnidirectional
Weight (kg): 10
Weight (lbs): 22.05
Fixture Finish: <a href="#">NIC / BRA / BBR</a>
Fixture Material: Metal
Cable Details: 2000mm Cable
Upon Request: Custom Sizes

#### ELECTRICAL

Number of Lamps: 156
Lamp Type: LED Retrofit
Input Wattage (W): 51.48
Bulb Included: Bulb Included
Max. Wattage Per Lamp (W): 0.33
Lamp Base: E10
<a href="#">Dimming: 0-10V Dimming / Phase Dimming (120Vac Only)</a>
Driver Included: Yes
Driver Location: Integrated
Driver Type: Constant Voltage - Universal
Driver Class: Class 2
Input Voltage (V): 120 - 277
Output Voltage (V): 12
Lamp Voltage (V): 12

#### LED

<a href="#">Color Temperature (°K): 2600 / 3000 / 3500</a>
Max. Delivered Lumen (lm): 3588 (2600K)
CRI: >90 CRI
Lamp Life (hrs): 50000

#### OPTICAL

#### RATINGS AND CERTIFICATIONS

Certified By: Certified for North American Standards
IP rating: IP20

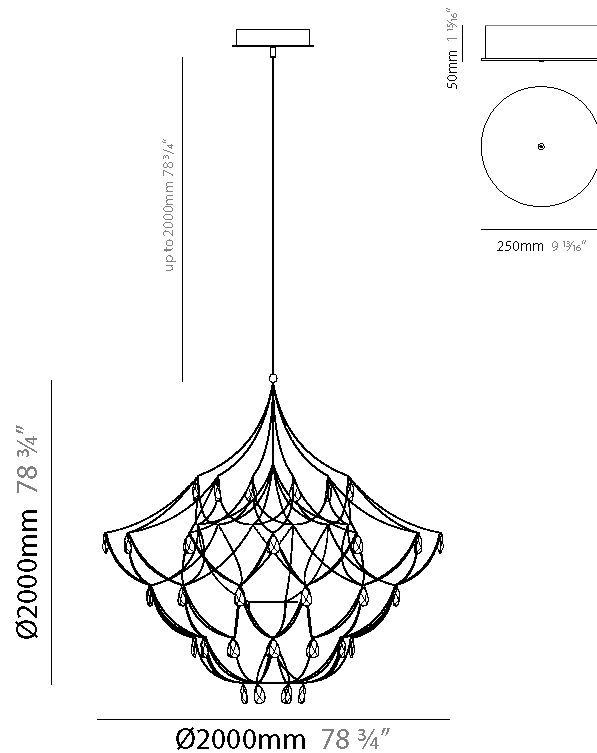

## CRYSTAL GALAXY SUSPENSION

D101417-

PROJECT

TYPE

SPECIFIER

QUANTITY

DATE



PROJECT	
TYPE	
SPECIFIER	
QUANTITY	
DATE	

## CRYSTAL GALAXY SUSPENSION

### D101418-

base number	LED Dimming	Color Temperature	Finish Options
-------------	-------------	-------------------	----------------

- To build a product code in our configurator select the specify button on the base model # product page
- To build a manual product code on this datasheet choose from the options listed below in blue font and add the suffix to the base model #

#### GENERAL

Series: Crystal Galaxy
Brand: Quasar
Division: Design
Mounting Type: Suspension
Mounting Location: Ceiling
Subcategory: Ambient

#### PHYSICAL

Shape: Abstract
Diameter (mm): 2000
Diameter (in): 78 3/4
Height (mm): 2000
Height (in): 78 3/4
Max. Overall Height (mm): 4000
Max. Overall Height (in): 157 1/2
Light Distribution: Omnidirectional
Fixture Finish: <a href="#">NIC</a> / <a href="#">BRA</a> / <a href="#">BBR</a>
Fixture Material: Metal
Cable Details: 2000mm Cable
Upon Request: Custom Sizes

#### ELECTRICAL

Number of Lamps: 156 + 1
Lamp Type: LED Retrofit
Input Wattage (W): 58.48
Bulb Included: Bulb Included
Max. Wattage Per Lamp (W): 0.33 + 7
Lamp Base: E10 + GU10
<a href="#">Dimming: 0-10V Dimming / Phase Dimming (120Vac Only)</a>
Driver Included: Yes
Driver Location: Integrated
Driver Type: Constant Voltage - Universal
Driver Class: Class 2
Input Voltage (V): 120 - 277
Output Voltage (V): 12
Lamp Voltage (V): 12

#### LED

<a href="#">Color Temperature (°K): 2600</a>
CRI: >90 CRI
Lamp Life (hrs): 50000

#### OPTICAL

#### RATINGS AND CERTIFICATIONS

Certified By: Certified for North American Standards
IP rating: IP20

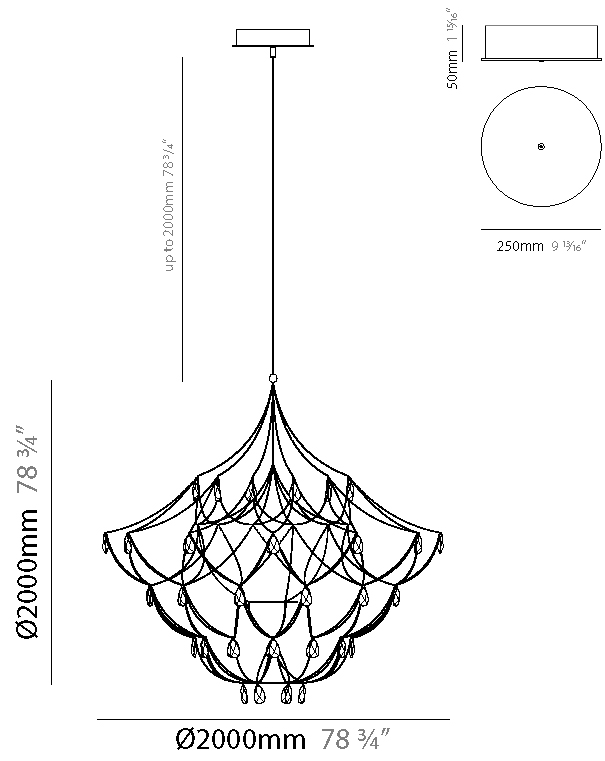

## CRYSTAL GALAXY SUSPENSION

D101418-

PROJECT

TYPE

SPECIFIER

QUANTITY

DATE

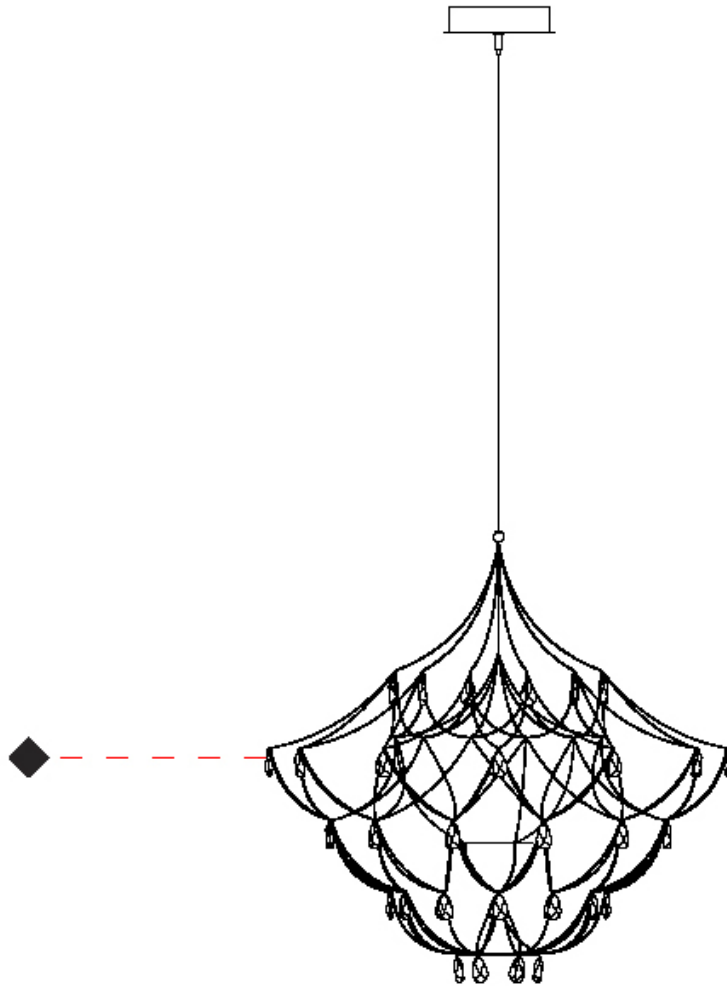

D



## CRYSTAL GALAXY SURFACE

### D102028-

base number    LED    Color    Finish  
 Dimming    Temperature    Options

- To build a product code in our configurator select the specify button on the base model # product page
- To build a manual product code on this datasheet choose from the options listed below in blue font and add the suffix to the base model #

#### GENERAL

Series: Crystal Galaxy  
 Brand: Quasar  
 Division: Design  
 Mounting Type: Surface  
 Mounting Location: Ceiling  
 Subcategory: Ambient

#### PHYSICAL

Shape: Abstract  
 Diameter (mm): 800  
 Diameter (in): 31 1/2  
 Height (mm): 500  
 Height (in): 19 11/16  
 Light Distribution: Omnidirectional  
 Weight (kg): 3  
 Weight (lbs): 6.61  
[Fixture Finish: NIC / BRA / BBR](#)  
 Fixture Material: Metal  
 Upon Request: Custom Sizes

#### ELECTRICAL

Number of Lamps: 54  
 Lamp Type: LED Retrofit  
 Input Wattage (W): 17.82  
 Bulb Included: Bulb Included  
 Max. Wattage Per Lamp (W): 0.33  
 Lamp Base: E10  
[Dimming: 0-10V Dimming / Phase Dimming \(120Vac Only\)](#)  
 Driver Included: Yes  
 Driver Location: Integrated  
 Driver Type: Constant Voltage - Universal  
 Driver Class: Class 2  
 Input Voltage (V): 120 - 277  
 Output Voltage (V): 12  
 Lamp Voltage (V): 12

#### LED

[Color Temperature \(°K\): 2600 / 3000 / 3500](#)  
 Max. Delivered Lumen (lm): 1242 (2600K)  
 CRI: >80 CRI  
 Lamp Life (hrs): 50000

#### OPTICAL

#### RATINGS AND CERTIFICATIONS

Certified By: Certified for North American Standards  
 IP rating: IP20

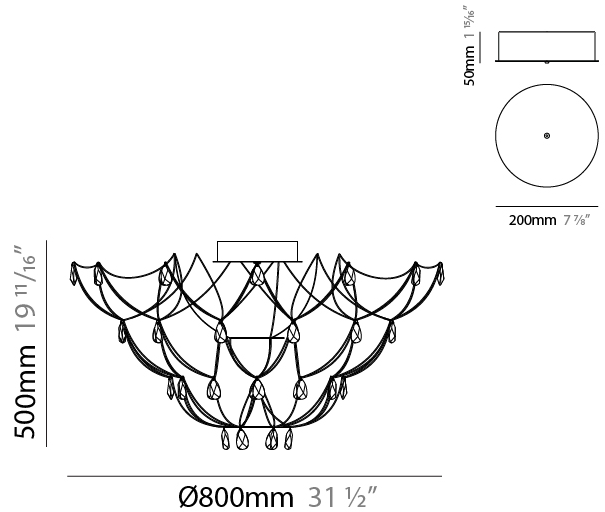

## CRYSTAL GALAXY SURFACE

D102028-

PROJECT \_\_\_\_\_

TYPE \_\_\_\_\_

SPECIFIER \_\_\_\_\_

QUANTITY \_\_\_\_\_

DATE \_\_\_\_\_

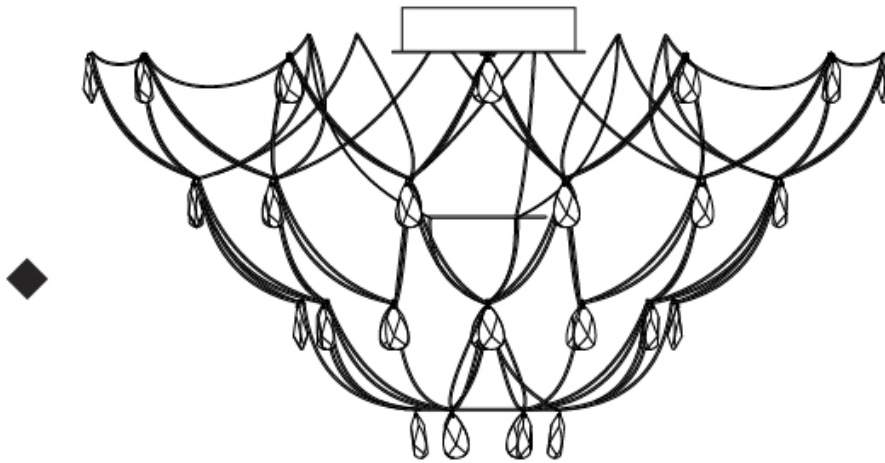



PROJECT	_____
TYPE	_____
SPECIFIER	_____
QUANTITY	_____
DATE	_____

## CRYSTAL GALAXY SURFACE

### D102029-

base number	LED	Color	Finish
	Dimming	Temperature	Options

- To build a product code in our configurator select the specify button on the base model # product page
- To build a manual product code on this datasheet choose from the options listed below in blue font and add the suffix to the base model #

#### GENERAL

Series: Crystal Galaxy
Brand: Quasar
Division: Design
Mounting Type: Surface
Mounting Location: Ceiling
Subcategory: Ambient

#### PHYSICAL

Shape: Abstract
Diameter (mm): 1000
Diameter (in): 39 3/8
Height (mm): 500
Height (in): 19 11/16
Light Distribution: Omnidirectional
Weight (kg): 3
Weight (lbs): 6.61
Fixture Finish: <a href="#">NIC / BRA / BBR</a>
Fixture Material: Metal
Upon Request: Custom Sizes

#### ELECTRICAL

Number of Lamps: 66
Lamp Type: LED Retrofit
Input Wattage (W): 21.78
Bulb Included: Bulb Included
Max. Wattage Per Lamp (W): 0.33
Lamp Base: E10
Dimming: <a href="#">0-10V Dimming / Phase Dimming (120Vac Only)</a>
Driver Included: Yes
Driver Location: Integrated
Driver Type: Constant Voltage - Universal
Driver Class: Class 2
Input Voltage (V): 120 - 277
Output Voltage (V): 12
Lamp Voltage (V): 12

#### LED

Color Temperature (°K): <a href="#">2600 / 3000 / 3500</a>
Max. Delivered Lumen (lm): 1518 (2600K)
CRI: >80 CRI
Lamp Life (hrs): 50000

#### OPTICAL

#### RATINGS AND CERTIFICATIONS

Certified By: Certified for North American Standards
IP rating: IP20

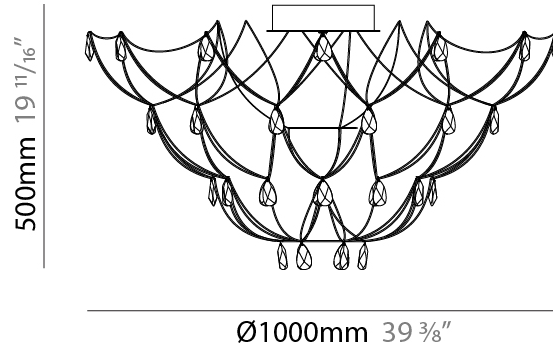
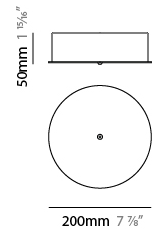

## CRYSTAL GALAXY SURFACE

D102029-

PROJECT

TYPE

SPECIFIER

QUANTITY

DATE

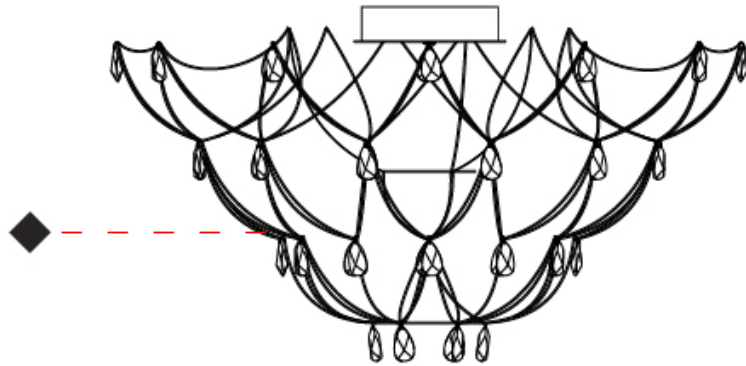

D

PROJECT \_\_\_\_\_

TYPE \_\_\_\_\_

SPECIFIER \_\_\_\_\_

QUANTITY \_\_\_\_\_

DATE \_\_\_\_\_

### Fixture Finish

Nickel - NIC



Brass - BRA



Black Brass - BBR

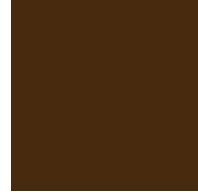

**Digital:** Not all screens are calibrated the same, and therefore, colors will appear differently between screens.

**Physical:** When texture is involved, there will be variations in color, character and tone within a product series and between product families.

Brass, nickel and copper are natural minerals and can potentially change color and show marks over time. We cannot guarantee the color appearance as the material transforms.



PROJECT	
TYPE	
SPECIFIER	
QUANTITY	
DATE	

### LEGEND

floor-mounted	pivotal	special LED (upon request) RGB, RGBW, tunable, gold+, meat+, art+, fashion+
wall and ceiling: recessed and surface mounted	rotating	warm dim / natural dimming LED
ceiling-mounted and wall-mounted	illuminate tilted	rechargeable battery powered
wall-mounted	color of suspension cable	fixture with natural vivid LED (upon request)
omni-directional light distribution	length of suspension cable	color rendering index
direct light distribution	reflector degree selection	color temperature
direct/indirect light distribution	super spot	lumen (luminous flux)
indirect light distribution	lens	efficacy (lumens per watt)
asymmetric light distribution	lens pack	Unified Glare Rating (UGR) range from 5-40
aura light distribution	shine ring	marine grade (AISI 316 stainless steel)
round wall or ceiling cut-out	integrated shine ring with diffuser	walk on
square wall or ceiling cut-out	free individual colors 01-29	drive on
the supplied jig specifies the cutout dimensions	individual colors: 00 (free of charge), 01-25 (extra charge)	Dark Sky Compliance
minimum distance (meters) lamp - object	luminaire part to be colored (F1)	Americans with Disabilities Act (less than 4" off the wall located between 27"-84" from floor)
recessed depth	luminaire part to be colored (F2)	lamp protected against explosion
ceiling thickness in mm	luminaire part to be colored (F3)	blown glass using traditional methods by master glass blower
ceiling thickness selection	luminaire part to be colored (F4)	acoustic material
dimmable DP (phase), DV (0-10V), DD (dali), DS (step-dim)	luminaire part to be colored (F5)	protection class I, protection insulation
included or excluded LED driver/transformer/control gear	color of 3-circuit adaptor	protection class II, protection insulation
separately switchable	indirect diffuser	ETL Certified to UL and CSA Standards
sensor	direct diffuser	UL Certified to UL and CSA Standards
remote control	ball-proof (upon request)	CSA Certified to UL and CSA Standards
available upon request	accessory	Certified for North American Standards

### IP RATING

IP20	protected against ingress of solid bodies greater than 12.5mm (finger)
IP33	protected against ingress of solid bodies greater than 2.5mm protected against sprays of water up to 60 degrees from the vertical (rain)
IP40	protected against ingress of solid bodies greater than 1mm (wire) no protection against the ingress of moisture
IP43	protected against ingress of solid bodies greater than 1mm (wire) protected against sprays of water up to 60 degrees from the vertical (rain)
IP44	protected against ingress of solid bodies greater than 1mm (wire) protected against water splashed from all directions
IP54	protected against limited ingress of dust (wet rooms/covered outdoor areas) protected against water splashed from all directions
IP65	protected against ingress of dust protected against jets of water
IP66	protected against ingress of dust protected against powerful jets of water or heavy seas
IP67	protected against ingress of dust protected against immersion of water between 15cm - 1m for 30 minutes
IP68	protected against ingress of dust protected against immersion of water under pressure for long periods

### IK RATING

IK01	protected against 0.14 joules impact (equivalent to 0.25kg mass dropped from 56mm above the surface)
IK02	protected against 0.2 joules impact (equivalent to 0.25kg mass dropped from 80mm above the surface)
IK03	protected against 0.35 joules impact (equivalent to 0.25kg mass dropped from 140mm above the surface)
IK04	protected against 0.5 joules impact (equivalent to 0.25kg mass dropped from 200mm above the surface)
IK05	protected against 0.7 joules impact (equivalent to 0.25kg mass dropped from 280mm above the surface)
IK06	protected against 1 joules impact (equivalent to 0.25kg mass dropped from 400mm above the surface)
IK07	protected against 2 joules impact (equivalent to 0.5kg mass dropped from 400mm above the surface)
IK08	protected against 5 joules impact (equivalent to 1.7kg mass dropped from 300mm above the surface)
IK09	protected against 10 joules impact (equivalent to 5.0kg mass dropped from 200mm above the surface)
IK10	protected against 20 joules impact (equivalent to 5.0kg mass dropped from 400mm above the surface)